

# ДОМКРАТЫ ТЕНЗОРНЫЕ PSTS



Архангельск (8182)63-90-72  
Астана (7172)727-132  
Астрахань (8512)99-46-04  
Барнаул (3852)73-04-60  
Белгород (4722)40-23-64  
Брянск (4832)59-03-52  
Владивосток (423)249-28-31  
Волгоград (844)278-03-48  
Вологда (8172)26-41-59  
Воронеж (473)204-51-73  
Екатеринбург (343)384-55-89

Иваново (4932)77-34-06  
Ижевск (3412)26-03-58  
Иркутск (395)279-98-46  
Казань (843)206-01-48  
Калининград (4012)72-03-81  
Калуга (4842)92-23-67  
Кемерово (3842)65-04-62  
Киров (8332)68-02-04  
Краснодар (861)203-40-90  
Красноярск (391)204-63-61  
Курск (4712)77-13-04  
Липецк (4742)52-20-81

Магнитогорск (3519)55-03-13  
Москва (495)268-04-70  
Мурманск (8152)59-64-93  
Набережные Челны (8552)20-53-41  
Нижний Новгород (831)429-08-12  
Новокузнецк (3843)20-46-81  
Новосибирск (383)227-86-73  
Омск (3812)21-46-40  
Орел (4862)44-53-42  
Оренбург (3532)37-68-04  
Пенза (8412)22-31-16

Пермь (342)205-81-47  
Ростов-на-Дону (863)308-18-15  
Рязань (4912)46-61-64  
Самара (846)206-03-16  
Санкт-Петербург (812)309-46-40  
Саратов (845)249-38-78  
Севастополь (8692)22-31-93  
Симферополь (3652)67-13-56  
Смоленск (4812)29-41-54  
Сочи (862)225-72-31  
Ставрополь (8652)20-65-13

Сургут (3462)77-98-35  
Тверь (4822)63-31-35  
Томск (3822)98-41-53  
Тула (4872)74-02-29  
Тюмень (3452)66-21-18  
Ульяновск (8422)24-23-59  
Уфа (347)229-48-12  
Хабаровск (4212)92-98-04  
Челябинск (351)202-03-61  
Череповец (8202)49-02-64  
Ярославль (4852)69-52-93

Россия (495)268-04-70 Киргизия (996)312-96-26-47 Казахстан (772)734-952-31

Единый адрес для всех регионов: [www.powermaster.nt-rt.ru](http://www.powermaster.nt-rt.ru) || [pwo@nt-rt.ru](mailto:pwo@nt-rt.ru)

## PSTS SERIES SPRING RETURN BOLT TENSIONERS

PSTS Series Bolt Tensioners are designed for operation in a wide variety of applications including pipeline flanges, heat exchangers, pressure vessels, compressor covers, boilers, feed pumps, anchors bolts and many others.

The PSTS Bolt Tensioner is very simple to use and consists of four parts -Threaded Puller, Load Cell, Bridge and Nut Rotating Socket.

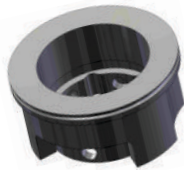
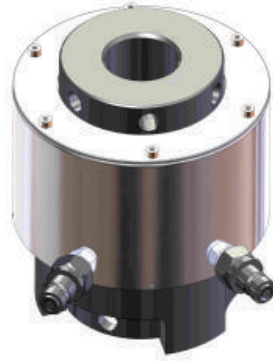

BRIDGE

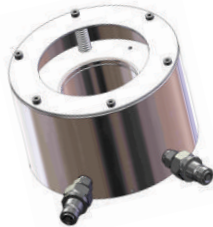

LOAD CELL

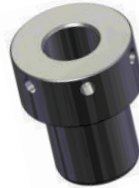

THREADED PULLER



NUT DRIVER

### *Features :*

- **Auto Spring Return:** Auto Spring Return Pressers the piston atomically on release of pressure and makes operation fast and easy.
- **Versatile Design:** The PSTS Series variable tensioners are designed to provide a wide range of flexibility, covering sizes from 7/8" to 5.3/4". Different stud sizes are accommodated by the same load cell by simply changing the adaptor kit.
- **High Strength Alloy Steel:** The PSTS Series tensioners operate at a maximum pressure of 1500 Bar and are manufactured from high strength AISI 4340 alloy steel, for long lasting trouble free performance.
- **Stroke Indicator:** The PSTS Series tensioners have an exceptional stroke of 15 mm. The Integral Stroke Indicator allows the piston stroke to be viewed while tensioning is in progress.
- **Safe Design:** The PSTS series tensioners are designed so that in event of over-stroke the high pressure fluid will be released from the inner side of the load cell, thus saving the operator from any potential exposure.
- **Multi Tensioning:** The PSTS Series load cell is provisioned with two connections and this acts as a manifold for multi applications. By using high pressure link hoses, any number of bolt tensioners can be connected and used simultaneously. This ensures equal tightening of all bolts on the flange.
- **Anti Roll, Composite Material Seals:** All PSTS Tensioners are fitted with Anti Roll, Composite Material seals for longer life and high reliability. The seals used have a low coefficient of friction so that the piston can be returned to a closed position with minimal effort.

# PSTS SERIES SPRING RETURN BOLT TENSIONERS

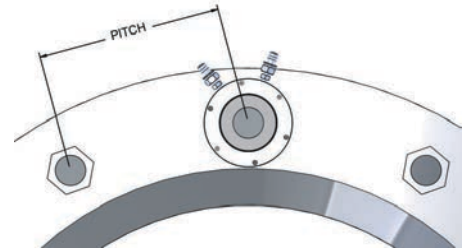
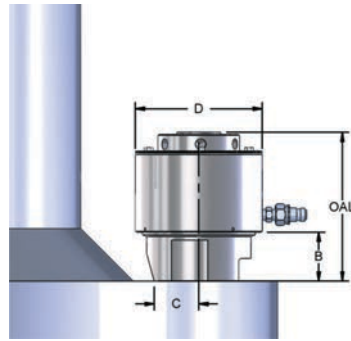
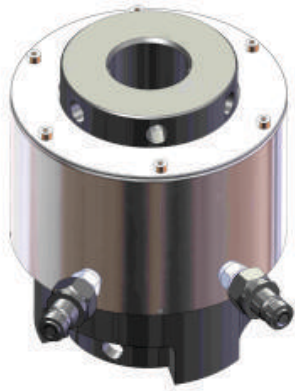

## Technical Details:

Load Cell	Adaptor Kit	Bolt Dia	Tool A/F	Max Load	D	OAL	B	C
Model	Model	inch	inch	kN	mm	mm	mm	mm
PSTS-02	AS01-0.14	7/8	1 7/16	397	98	123	30	27
	AS01-1.00	1	1 5/8			130	33	30
	AS01-1.02	1 1/8	1 13/16			136	37	33
	AS01-1.04	1 1/4	2			142	40	35
	AS01-1.06	1 3/8	2 3/16			149	43	38
PSTS-04	AS04-1.06	1 3/8	2 3/16	721	128	149	43	38
	AS04-1.08	1 1/2	2 3/8			155	46	41
	AS04-1.10	1 5/8	2 9/16			161	49	44
	AS04-1.12	1 3/4	2 3/4			168	52	46
PSTS-05	AS05-1.10	1 5/8	2 9/16	942	145	161	49	44
	AS05-1.12	1 3/4	2 3/4			168	52	46
	AS05-1.14	1 7/8	2 15/16			174	56	49
	AS05-2.00	2	3 1/8			180	59	52
PSTS-06	AS06-1.14	1 7/8	2 15/16	1354	165	174	56	49
	AS06-2.00	2	3 1/8			180	59	52
	AS06-2.04	2 1/4	3 1/2			193	65	57
PSTS-07	AS76-2.04	2 1/4	3 1/2	1651	182	193	65	57
	AS07-2.08	2 1/2	3 7/8			206	72	63
PSTS-08	AS08-2.08	2 1/2	3 7/8	1978	198	206	72	63
	AS08-2.12	2 3/4	4 1/4			218	78	68
PSTS-09	AS09-2.12	2 3/4	4 1/4	2257	215	218	78	68
	AS09-3.00	3	4 5/8			220	84	74
PSTS-10	AS10-3.04	3 1/4	5	3047	246	231	91	79
	AS10-3.08	3 1/2	5 3/8			243	97	85
	AS10-3.125	3 3/4	5 3/4			255	103	90
PSTS-11	AS11-3.12	3 3/4	5 3/4	3768	280	255	103	90
	AS11-4.00	4	6 1/8			267	110	96
	AS11-4.04	4 1/4	6 1/2			278	116	101
	AS11-4.08	4 1/2	6 7/8			290	122	107
	AS11-4.12	4 3/4	7 1/4			302	129	112
PSTS-12	AS12-5.00	5	7 5/8	4754	325	307	135	118
	AS12-5.04	5 1/4	8			319	141	123
	AS12-5.08	5 1/2	8 3/8			330	148	129
	AS12-5.12	5 3/4	8 3/4			342	154	134



Архангельск (8182)63-90-72  
Астана (7172)727-132  
Астрахань (8512)99-46-04  
Барнаул (3852)73-04-60  
Белгород (4722)40-23-64  
Брянск (4832)59-03-52  
Владивосток (423)249-28-31  
Волгоград (844)278-03-48  
Вологда (8172)26-41-59  
Воронеж (473)204-51-73  
Екатеринбург (343)384-55-89

Иваново (4932)77-34-06  
Ижевск (3412)26-03-58  
Иркутск (395)279-98-46  
Казань (843)206-01-48  
Калининград (4012)72-03-81  
Калуга (4842)92-23-67  
Кемерово (3842)65-04-62  
Киров (8332)68-02-04  
Краснодар (861)203-40-90  
Красноярск (391)204-63-61  
Курск (4712)77-13-04  
Липецк (4742)52-20-81

Магнитогорск (3519)55-03-13  
Москва (495)268-04-70  
Мурманск (8152)59-64-93  
Набережные Челны (8552)20-53-41  
Нижний Новгород (831)429-08-12  
Новокузнецк (3843)20-46-81  
Новосибирск (383)227-86-73  
Омск (3812)21-46-40  
Орел (4862)44-53-42  
Оренбург (3532)37-68-04  
Пенза (8412)22-31-16

Пермь (342)205-81-47  
Ростов-на-Дону (863)308-18-15  
Рязань (4912)46-61-64  
Самара (846)206-03-16  
Санкт-Петербург (812)309-46-40  
Саратов (845)249-38-78  
Севастополь (8692)22-31-93  
Симферополь (3652)67-13-56  
Смоленск (4812)29-41-54  
Сочи (862)225-72-31  
Ставрополь (8652)20-65-13

Сургут (3462)77-98-35  
Тверь (4822)63-31-35  
Томск (3822)98-41-53  
Тула (4872)74-02-29  
Тюмень (3452)66-21-18  
Ульяновск (8422)24-23-59  
Уфа (347)229-48-12  
Хабаровск (4212)92-98-04  
Челябинск (351)202-03-61  
Череповец (8202)49-02-64  
Ярославль (4852)69-52-93

Россия (495)268-04-70 Киргизия (996)312-96-26-47 Казахстан (772)734-952-31

Единый адрес для всех регионов: [www.powermaster.nt-rt.ru](http://www.powermaster.nt-rt.ru) || [pwo@nt-rt.ru](mailto:pwo@nt-rt.ru)